

## MV Large Umbrella

Meissl Open-Air Solutions — Your customized weather protection concept.  
We find your solution. Visit our website [www.meissl.com](http://www.meissl.com)

Celebrating outside.  
Since 1976.





## THE MEISSL MV LARGE UMBRELLA

A reason to celebrate outdoors – our Meissl MV large umbrella. The model with extra reinforced construction for extreme conditions. Available from 3,5 up to 8,5 metres diameter in round, rectangular or customized sizing – you name it. The MV is equipped with the signature Meissl technical features: Contemporary design and modern shapes, sophisticated light integration and either manual or electric operation. One of our essential large umbrellas in the Meissl family.

---

Special wishes? We've already considered them. The Meissl large umbrellas are available in various series that complement each other flawlessly. These are available in all sizes and shapes from 3 metres to 17 metres diameter. Our largest umbrella covers an area of 225 square metres. The Meissl MV Line is available from 3,5 metres diameter up to 8,5 metres diameter. Get out into your comfort zone – with our Meissl MV line.



## DIE MV BAUREIHE



Large umbrella in round, rectangular or customised design with up to 55 m<sup>2</sup> of covered area. Made entirely of aluminium with a square profile and manual or electric operation. A robust Meissl large umbrella.

Models	Umbrella size	Area covered	Drive
	5 m - 8,5 m	17,7 m <sup>2</sup> - 54,9 m <sup>2</sup>	manual / electric
	4 x 4 m - 7 x 7 m	16 m <sup>2</sup> - 49 m <sup>2</sup>	manual / electric
	4 x 3,5 m - 7,5 x 5,5 m	14 m <sup>2</sup> - 41,30 m <sup>2</sup>	manual / electric

\*Custom sizing is available upon request.

# THE MV LINE

## Technical Highlights



### User-friendly & functional operation

The MV large umbrella is smooth and elegant to operate – it is available with manual and motor drive operation.



### Light positioning – direct or indirect

Visible lighting elements are a thing of the past: For our Meissl large umbrellas we integrate the lighting directly into the rungs, for a discreet and dimmable look.



### Infrared heating for warmth in the colder moments

Our infrared heaters are compatible with all our products. Displaying a fresh design and constantly improved energy efficiency.

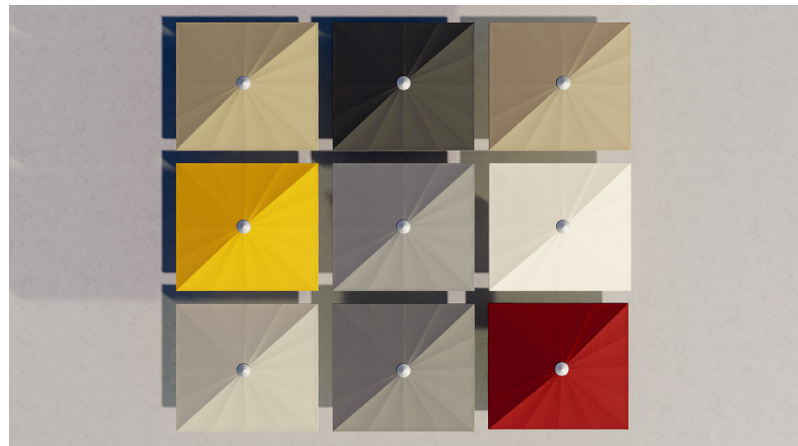

### Colours, shapes – your choice

You decide which shape and colours you would like for your new umbrella. We will make (almost) anything happen for you.

# EQUIPMENT AND ACCESSORIES

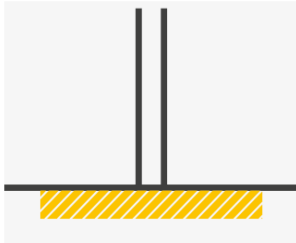

Mounting and foundation solutions



Customizable cover with fabric, colour and individual branding options

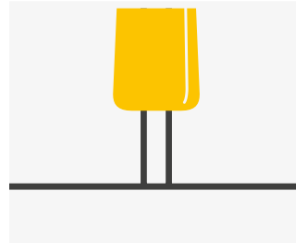

Protective umbrella covers

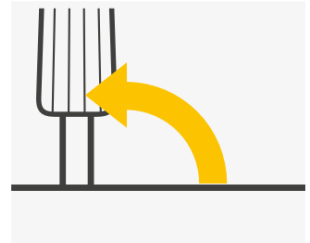

Set-up equipment

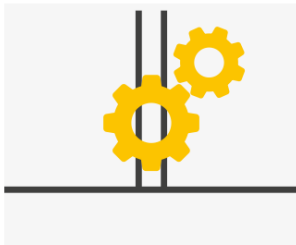

Electric drive

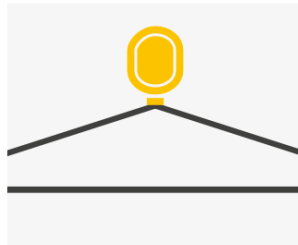

Advertising sign on the top of the umbrella

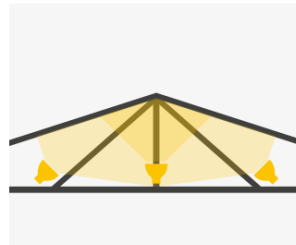

Lightning systems



Heating systems



Sound systems

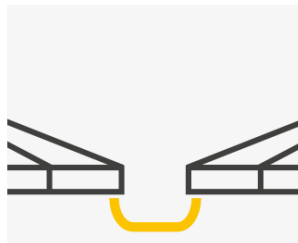

Rain gutters

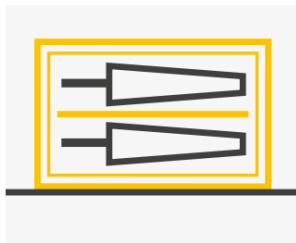

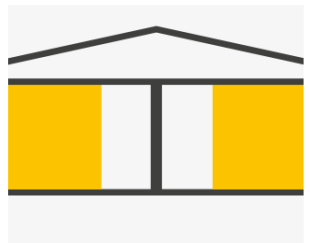

Transportation and storage protection





Textile sidewalls

# TECHNICAL DATA

## MV Umbrella sizes - METRIC

Models	Umbrella size	Area covered	Drive
	5 m - 8,5 m	17,7 m <sup>2</sup> - 54,9 m <sup>2</sup>	manual / electric
	4 x 4 m - 7 x 7 m	16 m <sup>2</sup> - 49 m <sup>2</sup>	manual / electric
	4 x 3,5 m - 7,5 x 5,5 m	14 m <sup>2</sup> - 41,30 m <sup>2</sup>	manual / electric

## MV Umbrella sizes - US

Models	Umbrella size	Area covered	Drive
	16,4 ft - 27,9 ft	190,5 - 590,9 ft <sup>2</sup>	manual / electric
	13,1 x 13,1 ft - 22,9 x 22,9 ft	172,2 - 527,4 ft <sup>2</sup>	manual / electric
	13,1 x 11,5 ft - 24,6 x 18 ft	150,7 - 444,6 ft <sup>2</sup>	manual / electric



# TECHNICAL DATA

## Windload

METRIC / MV

		MV
	Wind load	Open = 65 km/h* Closed = 147 km/h*

## Windload

US / MV

		MV
	Wind load	Open = 40 mph* Closed = 91 mph*

\*Wind and snowload for open and closed condition is based on a static calculation with security 1,0.



## COVER AND FABRIC CHOICES

We offer a high number of customization options.  
Umbrella cover fabric | COLLECTION 386



386 001  
Ruby

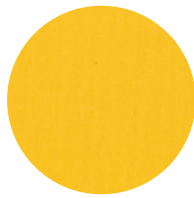

386 003  
Sulphur



386 033  
Aragonit



386 910  
Crystal



386 044  
Cinnabar



386 028  
Actinolite

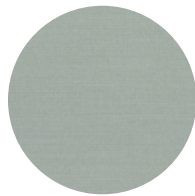

386 136  
Hematite



386 144  
Alabaster



386 713  
Bronzit



386 362  
Emerald

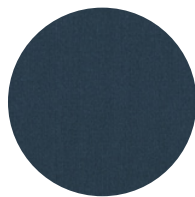

386 398  
Slate

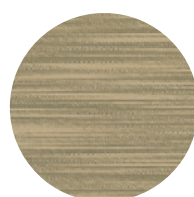

386 771  
Walnuss



386 020  
Dolomit



## COVER AND FABRIC CHOICES

We offer a high number of customization options.  
Umbrella cover fabric | COLLECTION 324



324 001  
Red



324 024  
Burgundy

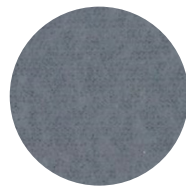

324 022  
Grey

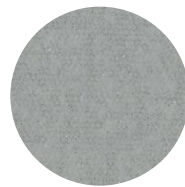

324 025  
Light Grey



324 023  
Beige

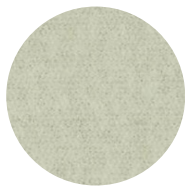

324 029  
Light Beige



324 028  
Black



324 010  
White

## COVER AND FABRIC CHOICES

We offer a high number of customization options.  
Umbrella cover fabric | COLLECTION 745



745 251 218



745 2M1

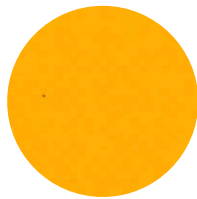

745 3M2

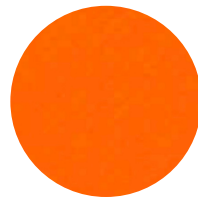

745 3M3

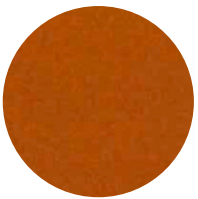

745 7M7



745 7M4



745 7M6



745 6M0

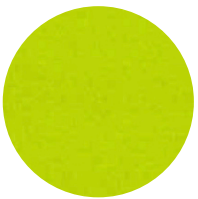

745 6M9

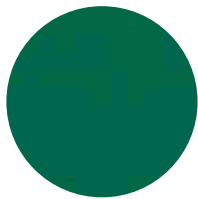

745 646

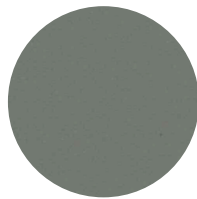

745 8M5



745 8M4



745 548



745 5M3



745 815 250



745 1M4  
White



745 1F4  
White Glossy



## CONSTRUCTION CHOICES

We offer a high number of customization options.  
Masts and struts | Construction Colour Collection

Our elox colour collection\_\_



E6 / Co  
Natural

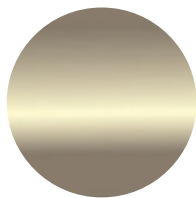

E6 / C32  
Light Bronze

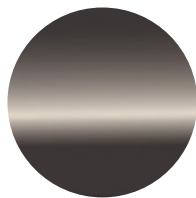

E6 / C34  
Dark Bronze

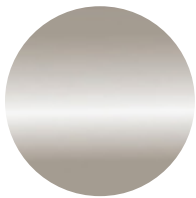

E6 / C31  
Light Bronze

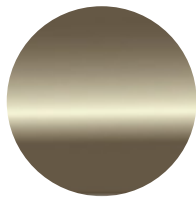

E6 / C33  
Medium Bronze

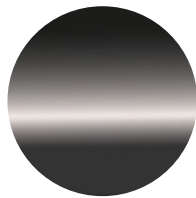

E6 / C35  
Black

A selection of RAL colours is available for coating\_\_



# FOUNDATION UMBRELLA TYPE MV

The flange of the umbrellas is below 0-level, level to the floor.

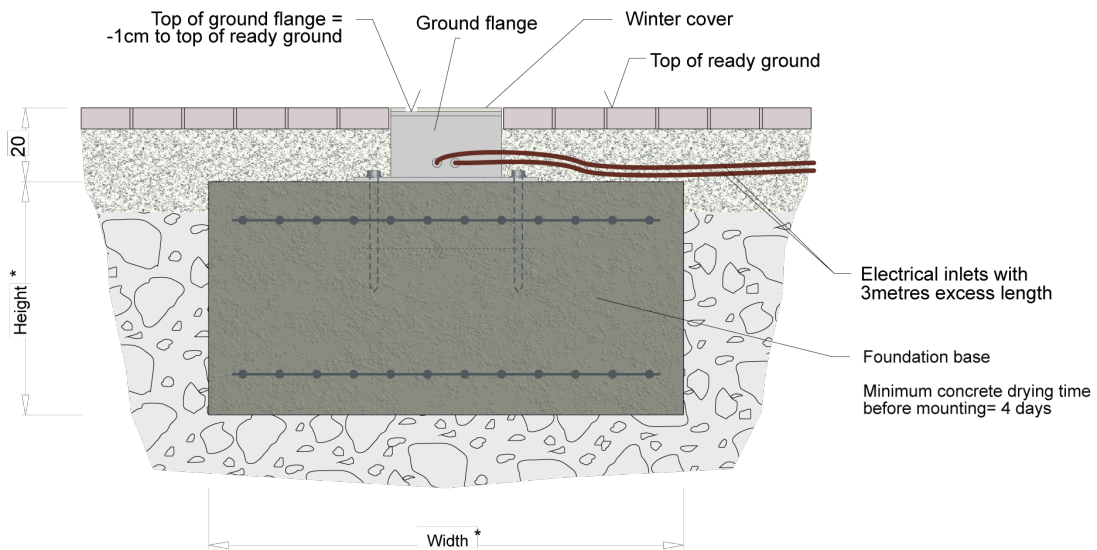
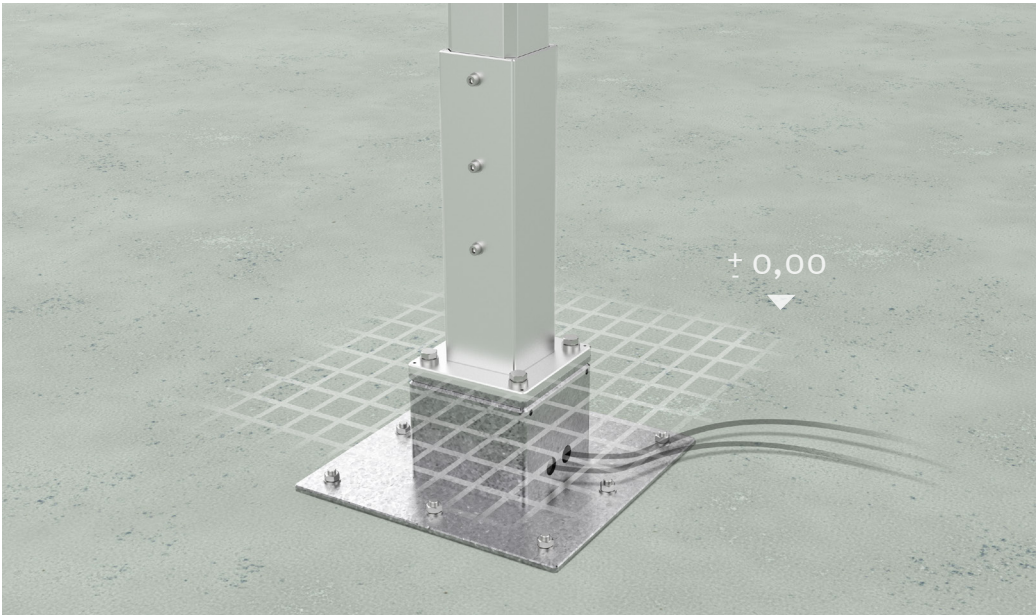

\*Measurements according to tech sheet 3-20/21/22.

# THE MEISSL MV LARGE UMBRELLA

## Model Overview

METRIC									US						
Model			Length (m)	Width (m)	covered		approx.		Length (ft)	Width (ft)	covered		approx.		
					area:		weight:				area:		weight:		
<b>ROUND DESIGN</b>															
6,2	m	0	12 parts	6,2	29,0	m <sup>2</sup>	130	kg		20,3	312,2	ft <sup>2</sup>	286	lbs	
6,5	m	0	12 parts	6,5	32,0	m <sup>2</sup>	135	kg		21,3	344,4	ft <sup>2</sup>	297	lbs	
7	m	0	12 parts	7,0	37,0	m <sup>2</sup>	140	kg		23,0	398,3	ft <sup>2</sup>	308	lbs	
7,5	m	0	12 parts	7,5	42,2	m <sup>2</sup>	150	kg		24,6	454,2	ft <sup>2</sup>	330	lbs	
8	m	0	14 parts	8,0	50,0	m <sup>2</sup>	165	kg		26,2	538,2	ft <sup>2</sup>	363	lbs	
8,5	m	0	14 parts	8,5	55,0	m <sup>2</sup>	175	kg		27,9	592,0	ft <sup>2</sup>	385	lbs	
<b>SQUARE DESIGN</b>															
3,5 x 3,5	m	□	8 parts	3,5	3,5	12,3	m <sup>2</sup>	115	kg	11,5	11,5	131,9	ft <sup>2</sup>	253	lbs
4,0 x 4,0	m	□	8 parts	4,0	4,0	16,0	m <sup>2</sup>	120	kg	13,1	13,1	172,2	ft <sup>2</sup>	264	lbs
4,5 x 4,5	m	□	8 parts	4,5	4,5	20,3	m <sup>2</sup>	130	kg	14,8	14,8	218,0	ft <sup>2</sup>	286	lbs
5,0 x 5,0	m	□	12 parts	5,0	5,0	25,0	m <sup>2</sup>	135	kg	16,4	16,4	269,1	ft <sup>2</sup>	297	lbs
5,5 x 5,5	m	□	12 parts	5,5	5,5	30,3	m <sup>2</sup>	145	kg	18,0	18,0	325,6	ft <sup>2</sup>	319	lbs
6,0 x 6,0	m	□	12 parts	6,0	6,0	36,0	m <sup>2</sup>	155	kg	19,7	19,7	387,5	ft <sup>2</sup>	341	lbs
6,5 x 6,5	m	□	12 parts	6,5	6,5	42,3	m <sup>2</sup>	165	kg	21,3	21,3	454,8	ft <sup>2</sup>	363	lbs
7,0 x 7,0	m	□	12 parts	7,0	7,0	49,0	m <sup>2</sup>	175	kg	23,0	23,0	527,4	ft <sup>2</sup>	385	lbs
<b>RECTANGULAR DESIGN</b>															
4,5 x 3,5	m	□	8 parts	4,5	3,5	15,8	m <sup>2</sup>	120	kg	14,8	11,5	169,5	ft <sup>2</sup>	264	lbs
4,5 x 4,0	m	□	8 parts	4,5	4,0	18,0	m <sup>2</sup>	125	kg	14,8	13,1	193,8	ft <sup>2</sup>	275	lbs
5,0 x 3,0	m	□	10 parts	5,0	3,0	15,0	m <sup>2</sup>	125	kg	16,4	9,8	161,5	ft <sup>2</sup>	275	lbs
5,0 x 3,5	m	□	10 parts	5,0	3,5	17,0	m <sup>2</sup>	120	kg	16,4	11,5	183,0	ft <sup>2</sup>	264	lbs
5,0 x 4,0	m	□	10 parts	5,0	4,0	20,0	m <sup>2</sup>	120	kg	16,4	13,1	215,3	ft <sup>2</sup>	264	lbs
5,0 x 4,5	m	□	10 parts	5,0	4,5	23,0	m <sup>2</sup>	125	kg	16,4	14,8	247,6	ft <sup>2</sup>	275	lbs
5,5 x 4,0	m	□	10 parts	5,5	4,0	22,0	m <sup>2</sup>	135	kg	18,0	13,1	236,8	ft <sup>2</sup>	297	lbs
5,5 x 4,5	m	□	10 parts	5,5	4,5	24,8	m <sup>2</sup>	132	kg	18,0	14,8	266,4	ft <sup>2</sup>	290	lbs
5,5 x 5,0	m	□	12 parts	5,5	5,0	28,0	m <sup>2</sup>	140	kg	18,0	16,4	301,4	ft <sup>2</sup>	308	lbs
6,0 x 3,0	m	□	10 parts	6,0	3,0	18,0	m <sup>2</sup>	125	kg	19,7	9,8	193,8	ft <sup>2</sup>	275	lbs
6,0 x 4,0	m	□	10 parts	6,0	4,0	24,0	m <sup>2</sup>	145	kg	19,7	13,1	258,3	ft <sup>2</sup>	319	lbs
6,0 x 4,5	m	□	10 parts	6,0	4,5	27,0	m <sup>2</sup>	135	kg	19,7	14,8	290,6	ft <sup>2</sup>	297	lbs
6,0 x 5,0	m	□	12 parts	6,0	5,0	30,0	m <sup>2</sup>	140	kg	19,7	16,4	322,9	ft <sup>2</sup>	308	lbs
6,0 x 5,5	m	□	12 parts	6,0	5,5	33,0	m <sup>2</sup>	145	kg	19,7	18,0	355,2	ft <sup>2</sup>	319	lbs
6,5 x 4,0	m	□	10 parts	6,5	4,0	26,0	m <sup>2</sup>	150	kg	21,3	13,1	279,9	ft <sup>2</sup>	330	lbs
6,5 x 4,5	m	□	10 parts	6,5	4,5	29,3	m <sup>2</sup>	135	kg	21,3	14,8	314,8	ft <sup>2</sup>	297	lbs
6,5 x 5,0	m	□	12 parts	6,5	5,0	32,5	m <sup>2</sup>	145	kg	21,3	16,4	349,8	ft <sup>2</sup>	319	lbs
6,5 x 5,5	m	□	12 parts	6,5	5,5	35,8	m <sup>2</sup>	150	kg	21,3	18,0	384,8	ft <sup>2</sup>	330	lbs
6,5 x 6,0	m	□	12 parts	6,5	6,0	39,0	m <sup>2</sup>	155	kg	21,3	19,7	419,8	ft <sup>2</sup>	341	lbs
7,0 x 5,0	m	□	12 parts	7,0	5,0	35,0	m <sup>2</sup>	160	kg	23,0	16,4	376,7	ft <sup>2</sup>	352	lbs
7,0 x 5,5	m	□	12 parts	7,0	5,5	38,5	m <sup>2</sup>	155	kg	23,0	18,0	414,4	ft <sup>2</sup>	341	lbs
7,0 x 6,0	m	□	12 parts	7,0	6,0	42,0	m <sup>2</sup>	160	kg	23,0	19,7	452,1	ft <sup>2</sup>	352	lbs
7,0 x 6,5	m	□	12 parts	7,0	6,5	46,0	m <sup>2</sup>	165	kg	23,0	21,3	495,1	ft <sup>2</sup>	363	lbs
7,5 x 5,0	m	□	14 parts	7,5	5,0	38,0	m <sup>2</sup>	180	kg	24,6	16,4	409,0	ft <sup>2</sup>	396	lbs
7,5 x 5,5	m	□	14 parts	7,5	5,5	41,0	m <sup>2</sup>	185	kg	24,6	18,0	441,3	ft <sup>2</sup>	407	lbs

# THE MEISSL MV HALF UMBRELLA



## Model Overview

METRIC										US				
			covered				approx.				covered			approx.
Length (m)	Width (m)	area:	weight:	Length (ft)	Width (ft)	area:	weight:							
<b>ROUND DESIGN</b>														
5	m	4 parts	5,00	8,85	m <sup>2</sup>	115	kg	16,40	95,26	ft <sup>2</sup>	253	lbs		
5,5	m	4 parts	5,50	10,70	m <sup>2</sup>	120	kg	18,04	115,17	ft <sup>2</sup>	264	lbs		
6	m	4 parts	6,00	12,75	m <sup>2</sup>	125	kg	19,69	137,24	ft <sup>2</sup>	275	lbs		
6,5	m	6 parts	6,50	14,95	m <sup>2</sup>	130	kg	21,33	160,92	ft <sup>2</sup>	286	lbs		
7	m	6 parts	7,00	18,40	m <sup>2</sup>	140	kg	22,97	198,06	ft <sup>2</sup>	308	lbs		
<b>RECTANGULAR DESIGN</b>														
4,0 x 2,0	m	4 parts	4,0	2,0	8,0	m <sup>2</sup>	110	kg	13,1	6,6	86,1	ft <sup>2</sup>	242	lbs
4,0 x 2,5	m	6 parts	4,0	2,5	10,0	m <sup>2</sup>	120	kg	13,1	8,2	107,6	ft <sup>2</sup>	264	lbs
4,0 x 3,0	m	6 parts	4,0	3,0	12,0	m <sup>2</sup>	125	kg	13,1	9,8	129,2	ft <sup>2</sup>	275	lbs
4,5 x 2,5	m	6 parts	4,5	2,5	11,3	m <sup>2</sup>	120	kg	14,8	8,2	121,1	ft <sup>2</sup>	264	lbs
4,5 x 3,0	m	6 parts	4,5	3,0	13,5	m <sup>2</sup>	125	kg	14,8	9,8	145,3	ft <sup>2</sup>	275	lbs
5,0 x 2,0	m	5 parts	5,0	2,0	10,0	m <sup>2</sup>	130	kg	16,4	6,6	107,6	ft <sup>2</sup>	286	lbs
5,0 x 2,5	m	7 parts	5,0	2,5	12,5	m <sup>2</sup>	135	kg	16,4	8,2	134,5	ft <sup>2</sup>	297	lbs
5,0 x 3,0	m	7 parts	5,0	3,0	15,0	m <sup>2</sup>	140	kg	16,4	9,8	161,5	ft <sup>2</sup>	308	lbs

Outside is our comfort zone.

office@meissl.com · +43 (0) 6462 2510-0 · www.meissl.com

